

DS80EP100

5 to 12.5 Gbps, Power-Saver Equalizer for Backplanes and Cables

General Description

National's Power-saver equalizer compensates for transmission medium losses and minimizes medium-induced deterministic jitter. Performance is guaranteed over the full range of 5 to 12.5 Gbps. The DS80EP100 requires no power to operate. The equalizer operates anywhere in the data path to minimize media-induced deterministic jitter in both FR4 traces and cable applications. Symmetric I/O structures support full duplex or half duplex applications. Linear compensation is provided independent of line coding or protocol. The device is ideal for both bi-level and multi-level signaling.

The equalizer is available in a 6 pin leadless LLP package with a space saving 2.2 mm X 2.5 mm footprint. This tiny package provides maximum flexibility in placement and routing of the Power-saver equalizer.

Features

- 5 to 12.5 Gbps Operation
- No Power or Ground Required
- Equalization effective anywhere in data path
- Equalizes CML, LV-PECL, LVDS signals
- Symmetric I/O structures provide equal boost for bi-directional operation
- 7 dB Maximum Boost
- Code independent, 8b/10b or Scrambled
- Supports both bi-level and multi-level signaling
- Extends reach over backplanes and cables
- Compatible with PCI-Express Gen1 and Gen2
- Compatible with XAU1
- Will operate in series with existing active Equalizer
- Easy to handle 6 pin LLP

Simplified Application Diagram

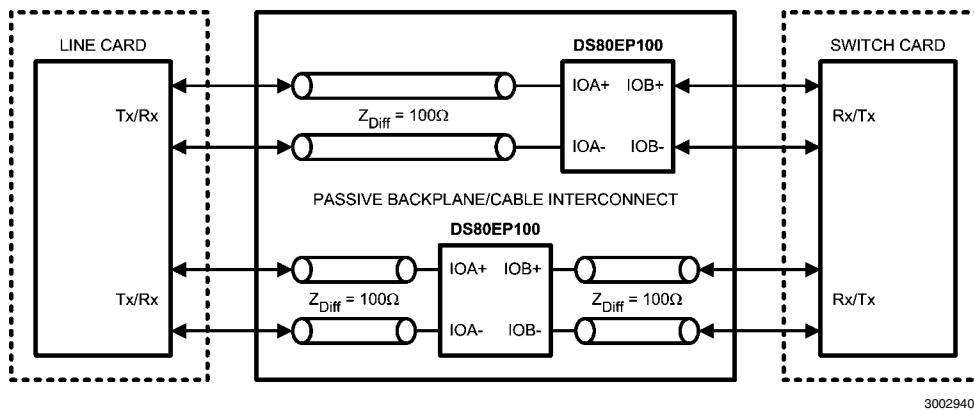

Note: The DS80EP100 provides the flexibility of passing the data from either side of the device. It can be placed anywhere in the data path.

Pin Descriptions

Pin Name	Pin Number	I/O Type	Description
High speed differential I/O			
IOA- IOA+	3 1	I/O	Symmetric differential I/O
IOB- IOB+	4 6	I/O	Symmetric differential I/O
NC Exposed Pad	2, 5 DAP	N/A	Reserved. Do not connect.

Note: I = Input / O = Output

Connection Diagram

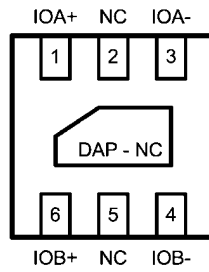

30029405
Bottom View Shown
2.2mm x 2.5mm 6-Pin LLP Package
Order Number DS80EP100
See NS Package Number SDA14A

Absolute Maximum Ratings (Note 1)

If Military/Aerospace specified devices are required, please contact the National Semiconductor Sales Office/Distributors for availability and specifications.

INPUT/OUTPUT

(IOA+ and IOB+) or (IOA- and IOB-)	+2V
(IOA+ and IOA-) or (IOB+ and IOB-)	+4V
(IOA+ and IOB-) or (IOA- and IOB+)	+4V
Junction Temperature	+150°C
Storage Temperature	-65°C to +150°C

Lead Temperature Soldering, 4 sec	+260°C
ESD Rating HBM, 1.5 k Ω , 100 pF	1.3kV

Recommended Operating Conditions

	Min	Typ	Max	Units
Ambient Temperature	-40	25	+85	°C
Bit Rate	5		12.5	Gbps

Electrical Characteristics (Note 6) Over recommended operating conditions unless other specified. All parameters are guaranteed by test, statistical analysis or design.

Symbol	Parameter	Conditions	Min	Typ (Note 2)	Max	Units
V_{IN}	Input voltage swing	(Note 3)		1000	3600	mVp-p
	Equalization	6.25 GHz relative to 100MHz		6		dB
R_{LI}	Differential input return loss	100 MHz – 6.25 GHz, with fixture's effect de-embedded		15		dB
R_{LO}	Differential output return loss	100 MHz – 6.25 GHz, with fixture's effect de-embedded IOA+, or IOB+ = static high.		15		dB
R_{IN}	Input Impedance	Differential across IOA+ and IOA-, or IOB+ and IOB-, ZLOAD = 100 Ω		100		Ω
R_O	Output Impedance	Differential across IOA+ and IOA-, or IOB+ and IOB-, ZSOURCE = 100 Ω		100		Ω
	Through Response	Relative to ideal load, see Figure 2 for setup	See Figure 3 and Table 1 for limits			
R1	Resistance IOA+ to IOA- and IOB+ to IOB-	No load, high impedance on all ports		150		Ω
R2	Resistance IOA+ to IOB+ and IOA- to IOB-	No load, high impedance on all ports		50		Ω
R3	Resistance IOA+ to IOB- and IOA- to IOB+	No load, high impedance on all ports		150		Ω
	DC Gain (IOA/IOB or IOB/IOA)	ZLOAD = 100 Ω		0.4		
DJ1	Residual deterministic jitter	5 Gbps, 20 in of 6mil microstrip FR4		0.15		Ulp-p
		See (Note 4)				
DJ2	Residual deterministic jitter	6.25 Gbps, 20 in of 6mil microstrip FR4		0.15	0.20	Ulp-p
		See (Notes 4, 5)				
DJ3	Residual deterministic jitter	8 Gbps, 20 in of 6mil microstrip FR4		0.15	0.20	Ulp-p
		See (Notes 4, 5)				
DJ4	Residual deterministic jitter	10 Gbps, 20 in of 6mil microstrip FR4 See (Note 4)		0.15		Ulp-p
DJ5	Residual deterministic jitter	12.5 Gbps, 14 in of 6mil microstrip FR4 See (Note 4)		0.15		Ulp-p

Note 1: "Absolute Maximum Ratings" indicate limits beyond which damage to the device may occur, including inoperability and degradation of device reliability and/or performance. Functional operation of the device and/or non-degradation at the Absolute Maximum Ratings or other conditions beyond those indicated in the Recommended Operating Conditions is not implied. The Recommended Operating Conditions indicate conditions at which the device is functional and the device should not be operated beyond such conditions.

Note 2: Typical values represent most likely parametric norms, TA = +25 degC, and at the Recommended Operation Conditions at the time of product characterization and are not guaranteed.

Note 3: Differential signal to Equalizer, measured at the input to a transmission line, see point A of *Figure 1*. The transmission line is $Z_0 = 100\Omega$, 6-mil, microstrip in FR4 material.

Note 4: Deterministic jitter is measured at the differential outputs (point C of *Figure 1*), minus the deterministic jitter before the test channel (point A of *Figure 1*). Test pattern: PRBS- 7 .

Note 5: Specification is guaranteed by characterization and is not tested in production.

Note 6: The Electrical Characteristics tables list guaranteed specifications under the listed Recommended Operating Conditions except as otherwise modified or specified by the Electrical Characteristics Conditions and/or Notes. Typical specifications are estimations only and are not guaranteed.

Test Setup Diagrams

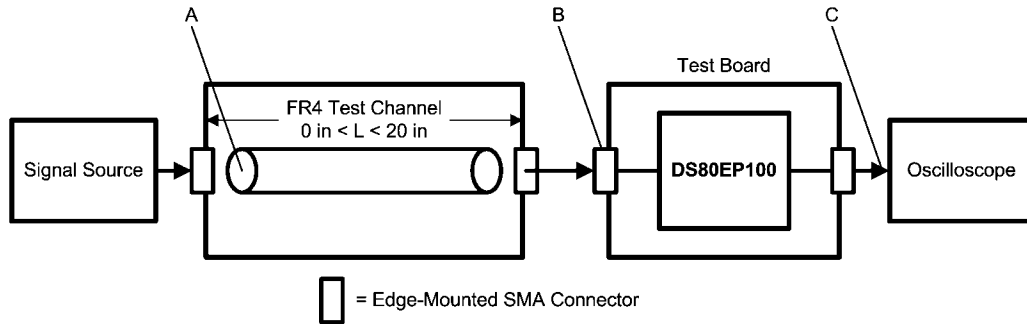

FIGURE 1. Transient Test Setup Diagram

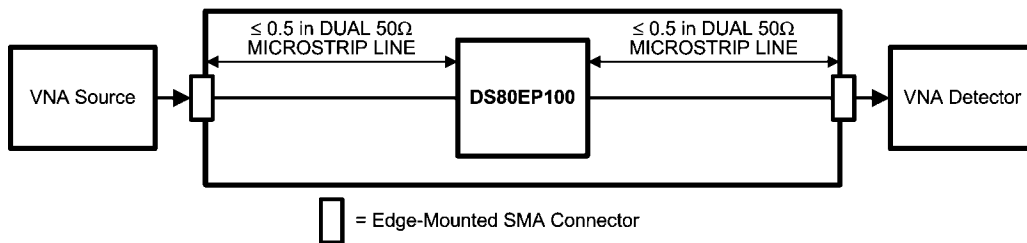

FIGURE 2. Frequency Response Test Circuit

Typical Equalizer Transfer Function

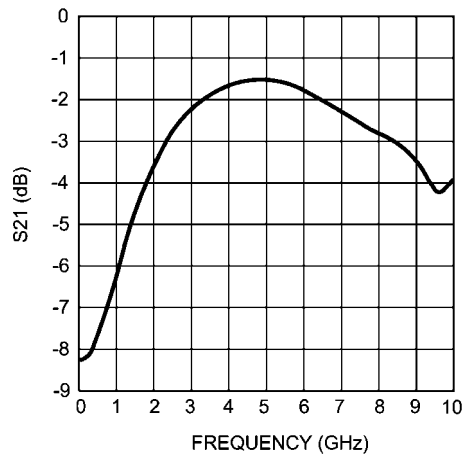
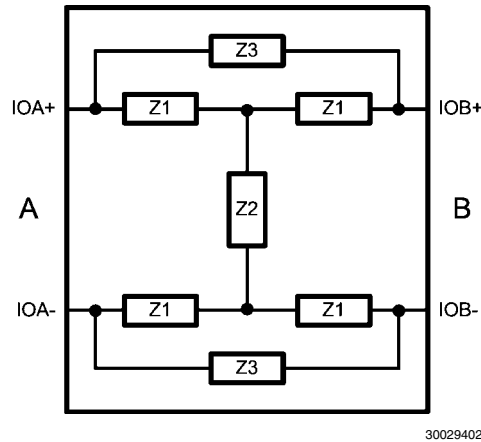

FIGURE 3. Typical Equalizer Transfer Function

Table 1. Typical Through Response

Frequency (GHz)	DS80EP100 Attenuation Typ (dB)
0.1	-8.25
0.5	-7.64
1	-6.12
1.5	-4.68
2	-3.57
3	-2.22
4	-1.66
5	-1.53
6	-1.77
7	-2.28
8	-2.8
9	-3.47
10	-3.91

Block Diagram

30029402

FIGURE 4. Simplified Block Diagram**Application Information****DS80EP100 DEVICE DESCRIPTION**

The DS80EP100 Power-Saver equalizer is a passive network circuit composed of resistive, capacitive, and inductive components (See *Figure 4*). A Differential bridged T-network compensates for the transmission medium losses and minimizes medium-induced deterministic jitter with FR4 and cables. The equalizer attenuates low frequency signals and is a bandpass filter at the resonant frequency. The response is linear and symmetric.

I/O TERMINATIONS

The DS80EP100 I/O impedance is 100Ω differential. The equalizer is designed for 100Ω-balanced differential signals and is not intended for single-ended transmission.

LINEAR COMPENSATION

The unique linear compensation feature of the DS80EP100 combined with the tiny package allows maximum flexibility in placement. The equalizer can be placed anywhere in the data

path and will provide the same compensation at the receiving circuit. (See Simplified Application Diagram)

SYMMETRIC I/O STRUCTURES

The symmetry of the passive equalization network allows bi-directional operation. Signals receive equal compensation regardless of the direction of data flow. (See Simplified Block Diagram).

PCB LAYOUT CONSIDERATIONS FOR DIFFERENTIAL PAIRS AND NO CONNECT PADS

The differential I/Os must have a controlled differential impedance of 100Ω. It is preferable to route all differential lines exclusively on one layer of the board. The use of vias should be avoided if possible. If vias must be used, they should be used sparingly and must be placed symmetrically for each side of a given differential pair. Differential signals should be routed away from other signals and noise sources on the printed circuit board. Pin 2, Pin 5, and the center DAP have to be left as no connect. Therefore, do not connect the landing pads of these pins to the power or ground plane. See AN-1187 for additional information on the LLP package.

Typical Performance Characteristics

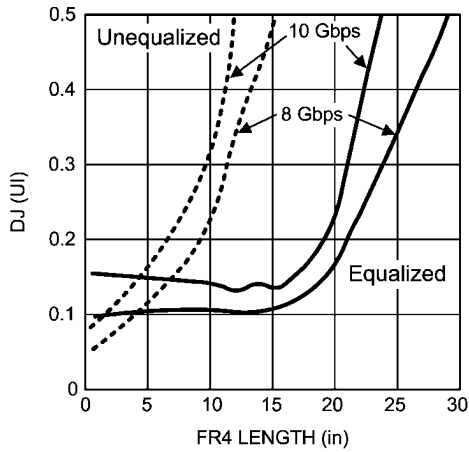

Residual Deterministic Jitter vs. FR4 Length 30029407

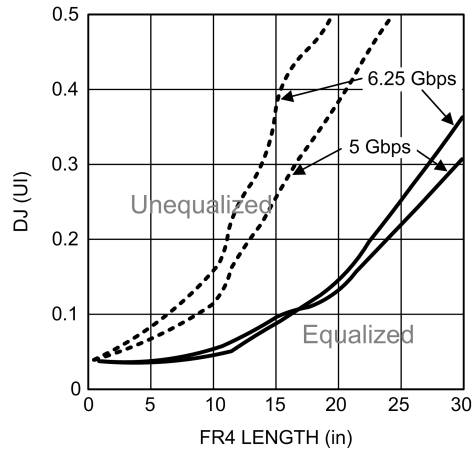

Residual Deterministic Jitter vs. FR4 Length 30029408

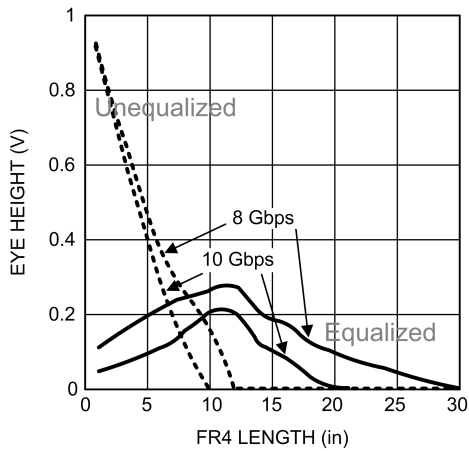

Eye Height vs. FR4 Length 30029409

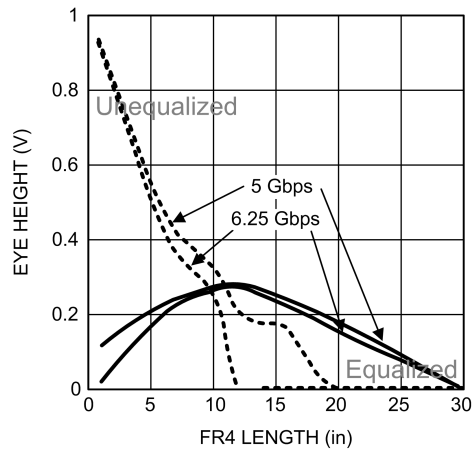

Eye Height vs. FR4 Length 30029410

Typical Eye Diagrams — Includes Transmitter Setup, Interconnect, and Device Total Jitter

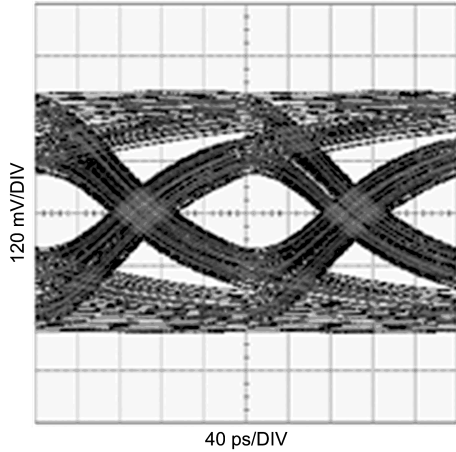

30029411

FIGURE 5. Unequalized Signal (20in FR4, 5Gbps, PRBS7)

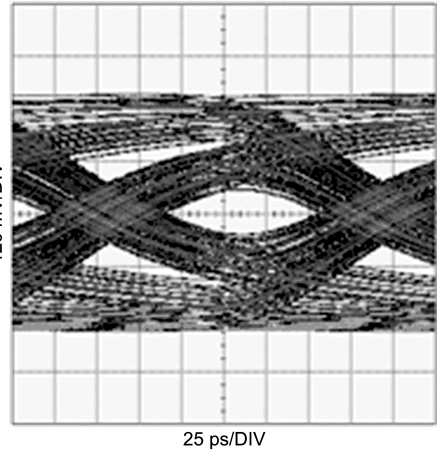

30029414

FIGURE 8. Unequalized Signal (20in FR4, 6.25Gbps, PRBS7)

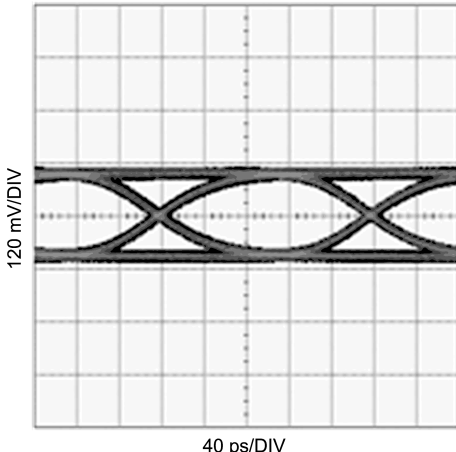

30029412

FIGURE 6. Equalized Signal (20in FR4, 5Gbps, PRBS7)

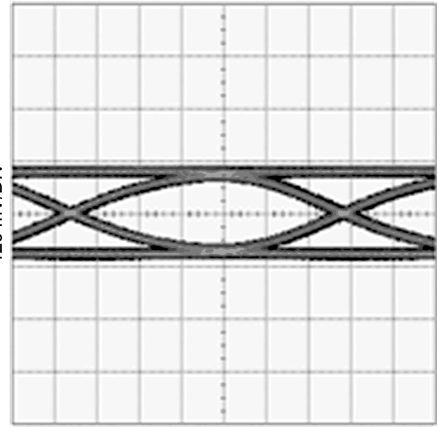

30029415

FIGURE 9. Equalized Signal (20in FR4, 6.25Gbps, PRBS7)

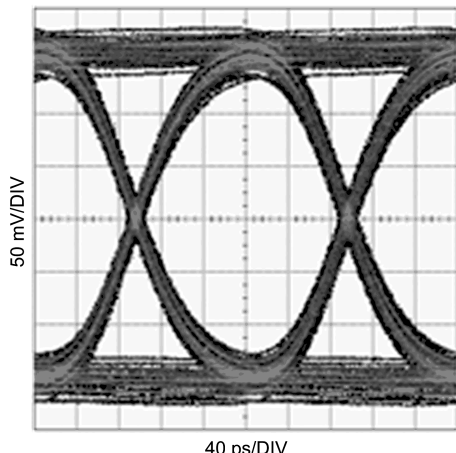

30029413

FIGURE 7. Equalized Signal (Zoom) (20in FR4, 5Gbps, PRBS7)

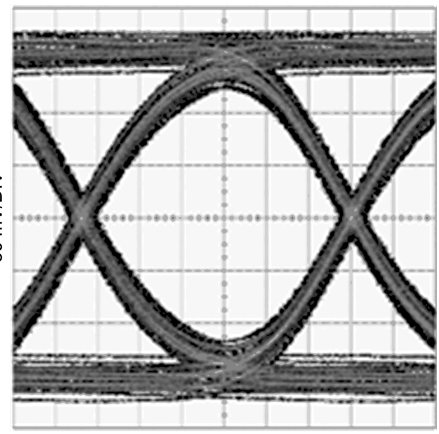

30029416

FIGURE 10. Equalized Signal (Zoom) (20in FR4, 6.26Gbps, PRBS7)

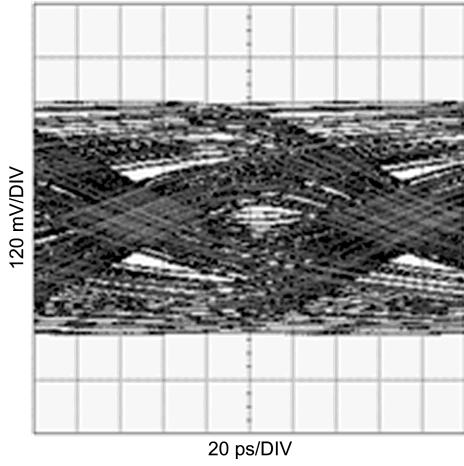

30029417

FIGURE 11. Unequalized Signal (20in FR4, 8Gbps, PRBS7)

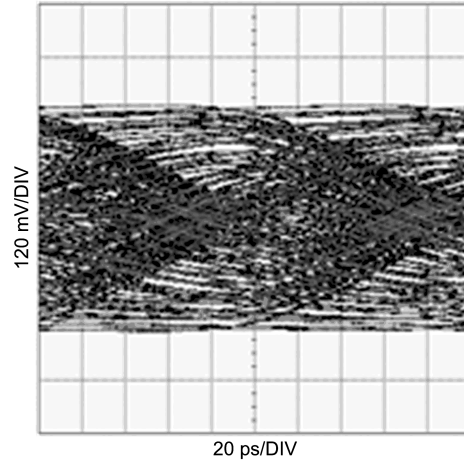

30029420

FIGURE 14. Unequalized Signal (20in FR4, 10Gbps, PRBS7)

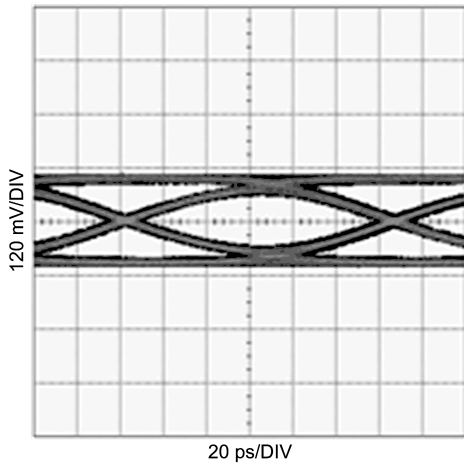

30029418

FIGURE 12. Equalized Signal (20in FR4, 8Gbps, PRBS7)

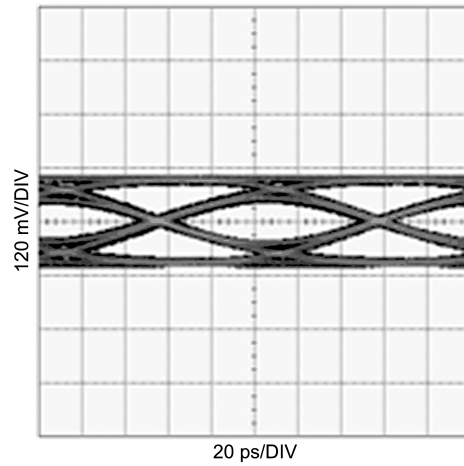

30029421

FIGURE 15. Equalized Signal (20in FR4, 10Gbps, PRBS7)

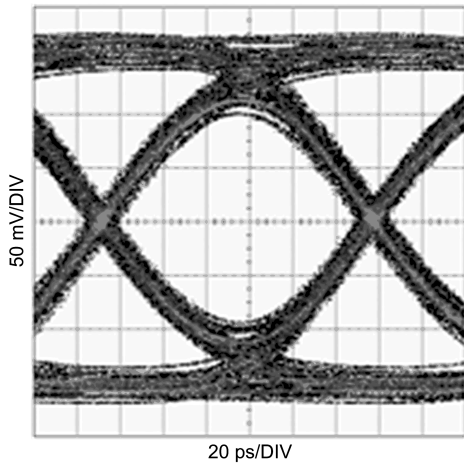

30029419

FIGURE 13. Equalized Signal (Zoom) (20in FR4, 8Gbps, PRBS7)

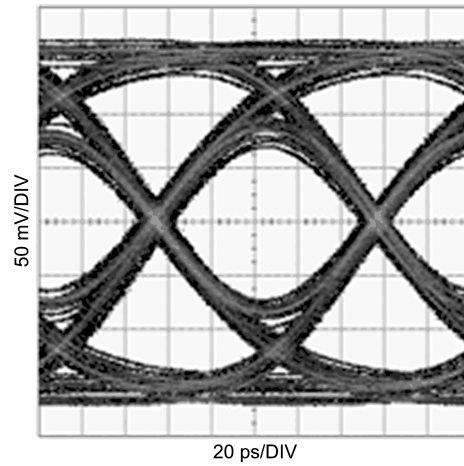

30029422

FIGURE 16. Equalized Signal (Zoom) (20in FR4, 10Gbps, PRBS7)

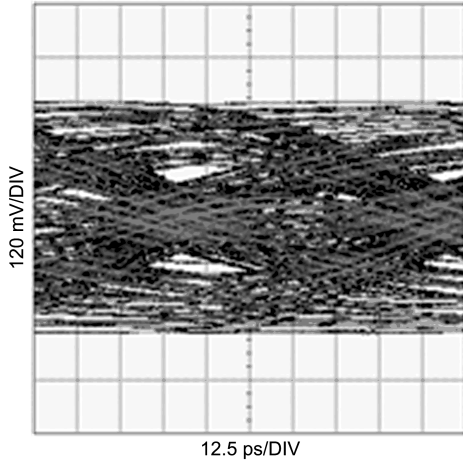

30029423

FIGURE 17. Unequalized Signal (14in FR4, 12.5Gbps, PRBS7)

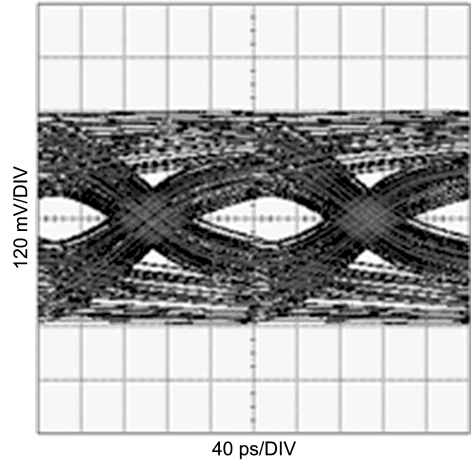

30029426

FIGURE 20. Unequalized Signal (5m 26AWG Twin-AX Cable, 5Gbps, PRBS7)

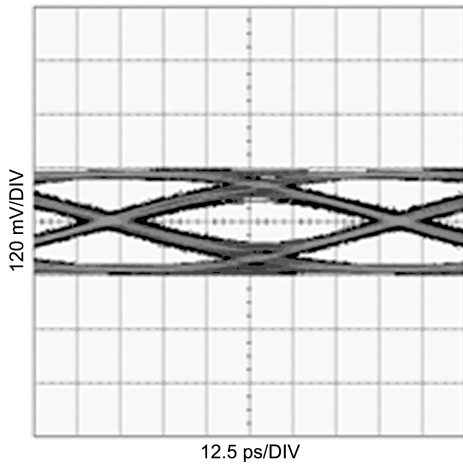

30029424

FIGURE 18. Equalized Signal (14in FR4, 12.5Gbps, PRBS7)

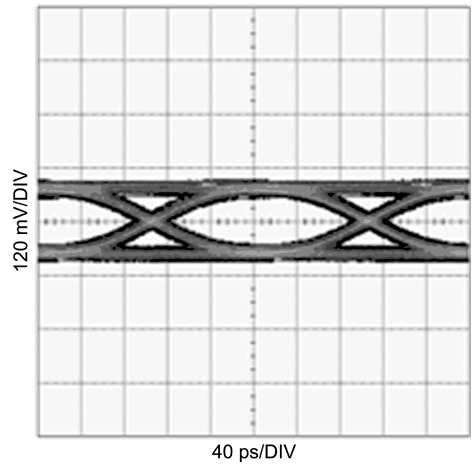

30029427

FIGURE 21. Equalized Signal (5m 26AWG Twin-AX Cable, 5Gbps, PRBS7)

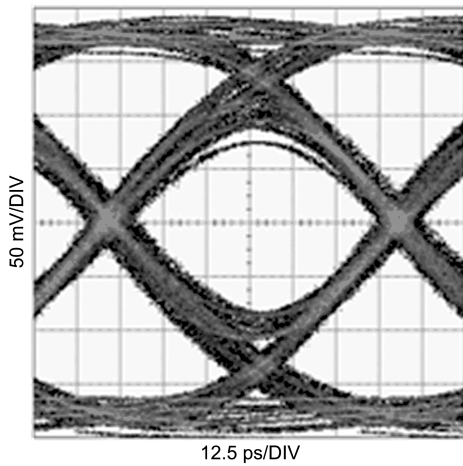

30029425

FIGURE 19. Equalized Signal (Zoom) (14in FR4, 12.5Gbps, PRBS7)

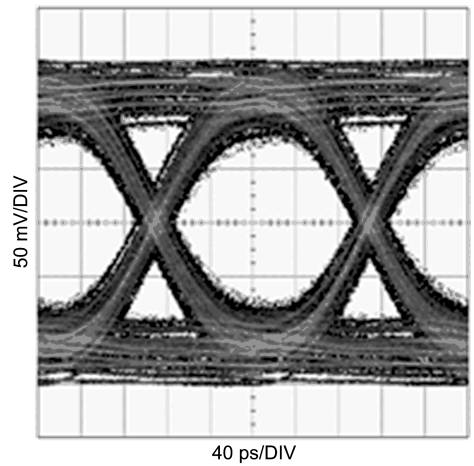

30029428

FIGURE 22. Equalized Signal (Zoom) (5m 26AWG Twin-AX Cable, 5Gbps, PRBS7)

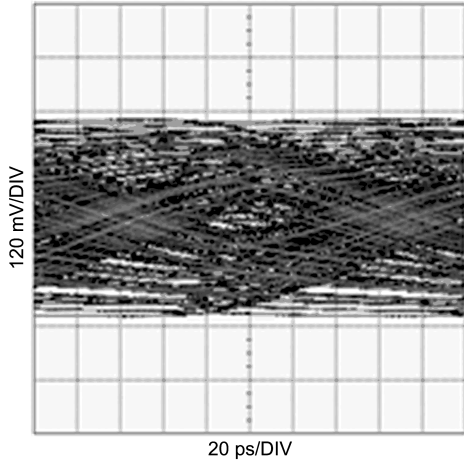

30029429

FIGURE 23. Unequalized Signal (5m 26AWG Twin-AX Cable, 8Gbps, PRBS7)

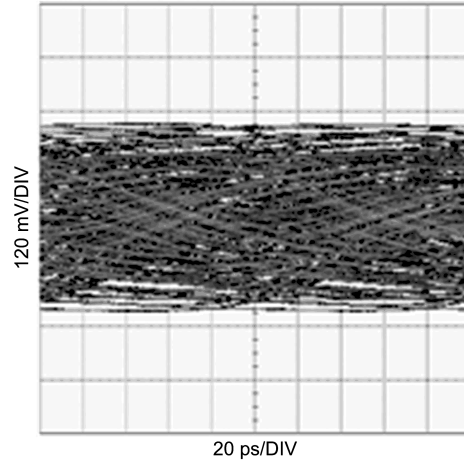

30029432

FIGURE 26. Unequalized Signal (5m 26AWG Twin-AX Cable, 10Gbps, PRBS7)

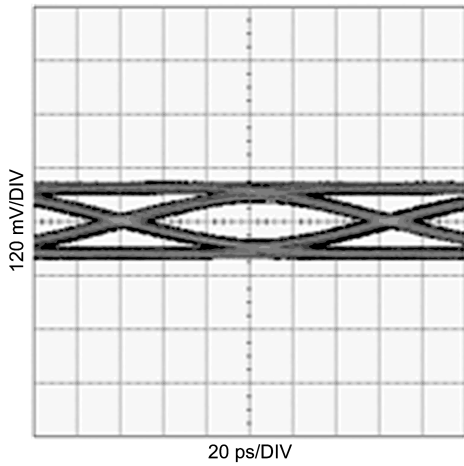

30029430

FIGURE 24. Equalized Signal (5m 26AWG Twin-AX Cable, 8Gbps, PRBS7)

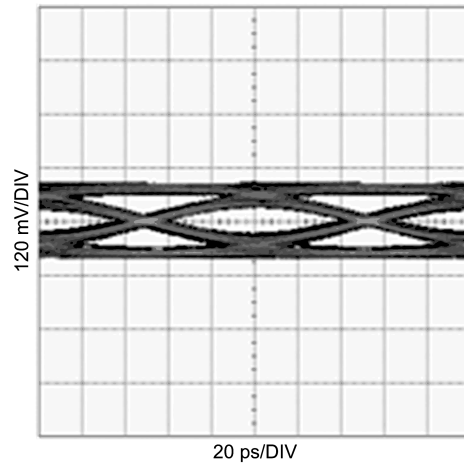

30029433

FIGURE 27. Equalized Signal (5m 26AWG Twin-AX Cable, 10Gbps, PRBS7)

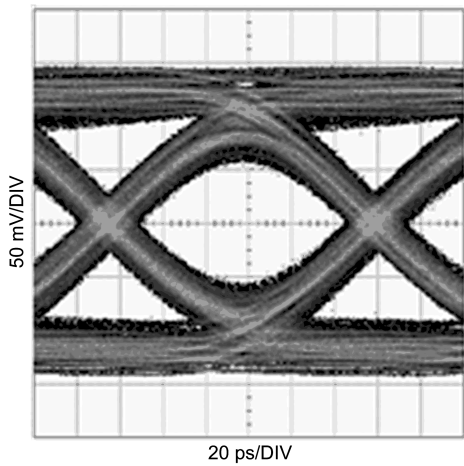

30029431

FIGURE 25. Equalized Signal (Zoom) (5m 26AWG Twin-AX Cable, 8Gbps, PRBS7)

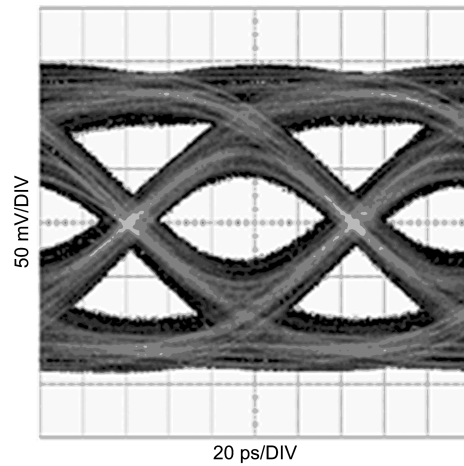

30029434

FIGURE 28. Equalized Signal (Zoom) (5m 26AWG Twin-AX Cable, 10Gbps, PRBS7)

Notes

Notes

For more National Semiconductor product information and proven design tools, visit the following Web sites at:

Products		Design Support	
Amplifiers	www.national.com/amplifiers	WEBENCH	www.national.com/webench
Audio	www.national.com/audio	Analog University	www.national.com/AU
Clock Conditioners	www.national.com/timing	App Notes	www.national.com/appnotes
Data Converters	www.national.com/adc	Distributors	www.national.com/contacts
Displays	www.national.com/displays	Green Compliance	www.national.com/quality/green
Ethernet	www.national.com/ethernet	Packaging	www.national.com/packaging
Interface	www.national.com/interface	Quality and Reliability	www.national.com/quality
LVDS	www.national.com/lvds	Reference Designs	www.national.com/refdesigns
Power Management	www.national.com/power	Feedback	www.national.com/feedback
Switching Regulators	www.national.com/switchers		
LDOs	www.national.com/lido		
LED Lighting	www.national.com/led		
PowerWise	www.national.com/powerwise		
Serial Digital Interface (SDI)	www.national.com/sdi		
Temperature Sensors	www.national.com/tempsensors		
Wireless (PLL/VCO)	www.national.com/wireless		

THE CONTENTS OF THIS DOCUMENT ARE PROVIDED IN CONNECTION WITH NATIONAL SEMICONDUCTOR CORPORATION ("NATIONAL") PRODUCTS. NATIONAL MAKES NO REPRESENTATIONS OR WARRANTIES WITH RESPECT TO THE ACCURACY OR COMPLETENESS OF THE CONTENTS OF THIS PUBLICATION AND RESERVES THE RIGHT TO MAKE CHANGES TO SPECIFICATIONS AND PRODUCT DESCRIPTIONS AT ANY TIME WITHOUT NOTICE. NO LICENSE, WHETHER EXPRESS, IMPLIED, ARISING BY ESTOPPEL OR OTHERWISE, TO ANY INTELLECTUAL PROPERTY RIGHTS IS GRANTED BY THIS DOCUMENT.

TESTING AND OTHER QUALITY CONTROLS ARE USED TO THE EXTENT NATIONAL DEEMS NECESSARY TO SUPPORT NATIONAL'S PRODUCT WARRANTY. EXCEPT WHERE MANDATED BY GOVERNMENT REQUIREMENTS, TESTING OF ALL PARAMETERS OF EACH PRODUCT IS NOT NECESSARILY PERFORMED. NATIONAL ASSUMES NO LIABILITY FOR APPLICATIONS ASSISTANCE OR BUYER PRODUCT DESIGN. BUYERS ARE RESPONSIBLE FOR THEIR PRODUCTS AND APPLICATIONS USING NATIONAL COMPONENTS. PRIOR TO USING OR DISTRIBUTING ANY PRODUCTS THAT INCLUDE NATIONAL COMPONENTS, BUYERS SHOULD PROVIDE ADEQUATE DESIGN, TESTING AND OPERATING SAFEGUARDS.

EXCEPT AS PROVIDED IN NATIONAL'S TERMS AND CONDITIONS OF SALE FOR SUCH PRODUCTS, NATIONAL ASSUMES NO LIABILITY WHATSOEVER, AND NATIONAL DISCLAIMS ANY EXPRESS OR IMPLIED WARRANTY RELATING TO THE SALE AND/OR USE OF NATIONAL PRODUCTS INCLUDING LIABILITY OR WARRANTIES RELATING TO FITNESS FOR A PARTICULAR PURPOSE, MERCHANTABILITY, OR INFRINGEMENT OF ANY PATENT, COPYRIGHT OR OTHER INTELLECTUAL PROPERTY RIGHT.

LIFE SUPPORT POLICY

NATIONAL'S PRODUCTS ARE NOT AUTHORIZED FOR USE AS CRITICAL COMPONENTS IN LIFE SUPPORT DEVICES OR SYSTEMS WITHOUT THE EXPRESS PRIOR WRITTEN APPROVAL OF THE CHIEF EXECUTIVE OFFICER AND GENERAL COUNSEL OF NATIONAL SEMICONDUCTOR CORPORATION. As used herein:

Life support devices or systems are devices which (a) are intended for surgical implant into the body, or (b) support or sustain life and whose failure to perform when properly used in accordance with instructions for use provided in the labeling can be reasonably expected to result in a significant injury to the user. A critical component is any component in a life support device or system whose failure to perform can be reasonably expected to cause the failure of the life support device or system or to affect its safety or effectiveness.

National Semiconductor and the National Semiconductor logo are registered trademarks of National Semiconductor Corporation. All other brand or product names may be trademarks or registered trademarks of their respective holders.

Copyright© 2008 National Semiconductor Corporation

For the most current product information visit us at www.national.com



**National Semiconductor
Americas Technical
Support Center**
Email: support@nsc.com
Tel: 1-800-272-9959

**National Semiconductor Europe
Technical Support Center**
Email: europe.support@nsc.com
German Tel: +49 (0) 180 5010 771
English Tel: +44 (0) 870 850 4288

**National Semiconductor Asia
Pacific Technical Support Center**
Email: ap.support@nsc.com

**National Semiconductor Japan
Technical Support Center**
Email: jpn.feedback@nsc.com